

BRM-100

Backreflection Meter



Product Overview

The BRM-100 Backreflection Meter is an instrument developed with extremely stable optics for precise measurement of backreflection, insertion loss, and power.

Available with 1, 4, 12, 16, 24, 32, 48 or 72 output channels, the BRM is a practical choice for both single-fiber and multifiber testing.

BRM-100 features up to four built-in sources at wavelengths of 450, 650, 780, 850, 1060, 1300, 1310, 1490, 1550, 1625 or 1650 nm. Custom configurations available upon request.

BRM-100 boasts the best backreflection accuracy in its class (± 0.4 dB) with a measurement sensitivity down to -85 dB. Choose the integrating sphere detector option for multifiber assemblies such as MPO or duplex LC. You can use the BRM with our free GMS software for automated testing. The multimode BRM is internally conditioned to meet the IEC 61280-4-1 Encircled Flux standard.

Features

- Stable BR measurements at low values
- Up to 72 output channels
- Up to 4 internal sources
- Custom sources and core sizes possible



Applications

- Testing IL/BR of fiber optic components and assemblies
- Single-fiber and multifiber testing
- Incoming inspection
- QA and R&D testing



Compliance

- MM meets IEC 61280-4-1 Encircled Flux Standard
- UL/CSA 61010
- IEC 61010
- FCC Part 15 (Class A)
- EN 61326 (Class A)

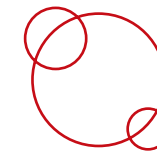

Optimized for Speed and Accuracy

BRM-100 uses very reliable OCWR technology to measure SM BR from 0 to -85 dB (-60 dB for MM) with an unmatched ± 0.4 dB accuracy. The extremely fast BRM can measure IL/BR of 12 fiber devices at 2 wavelengths under 20 seconds. This multichannel version has a switch built-in to optimize the optics.

Ideal For Component and Cassette Testing

With no minimum length, BRM-100 is ideal for testing short devices like fiber arrays and cassettes. The BR of components with multiple reflective events is easily measured while the NIST-traceable absolute power capability is convenient for transceiver and active component testing.

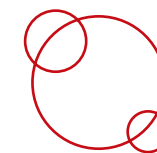
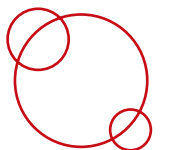

Integrating Sphere Detector

For measuring on multifiber connectors such as MPO, fiber arrays or wide beam connectors, choose the integrating sphere option. It is manufactured as a single piece which gives it the best performance in its class. The patented SD Slide Detector Adapters are another innovation designed to facilitate high throughput testing. The remote-head option adds extra flexibility.

Measurements Made Easy

For quick benchtop testing, BRM-100 large front panel touchscreen is convenient and easy to use. The free GMS software is used by countless production and lab facilities all around the world, it is both simple to use and flexible. Results can be automatically saved and reports exported to Excel/PDF and printed. If you want to write your own software, BRM-100 is programmable via USB and Ethernet with SCPI commands.

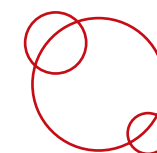
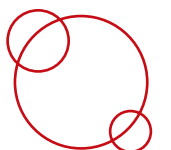

Customizable

Building smaller, less common core sizes as small as 3 μ m can be a challenge, but with our decades of experience in creating custom units, we'll collaborate with you to ensure you receive a meter that fits your application needs.

Ordering Scheme & Instructions

1. Configure BRM Backreflection Meter

Single-mode Version

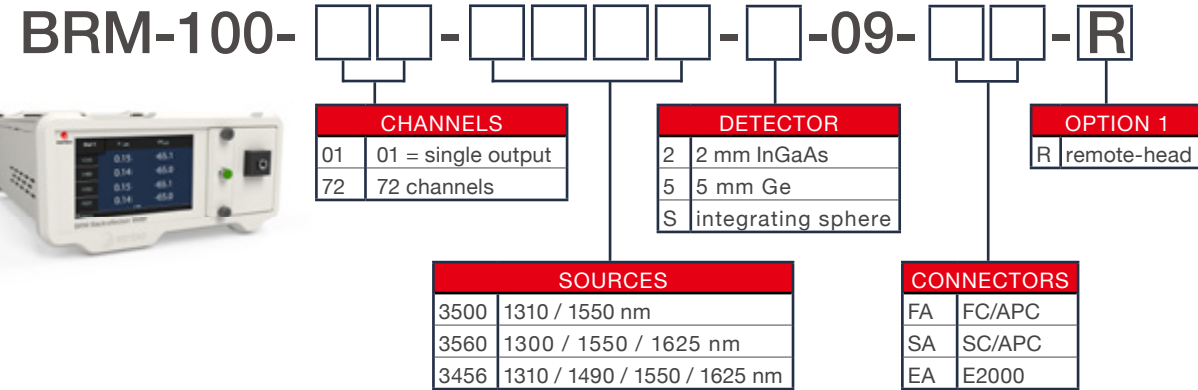

Multimode Version

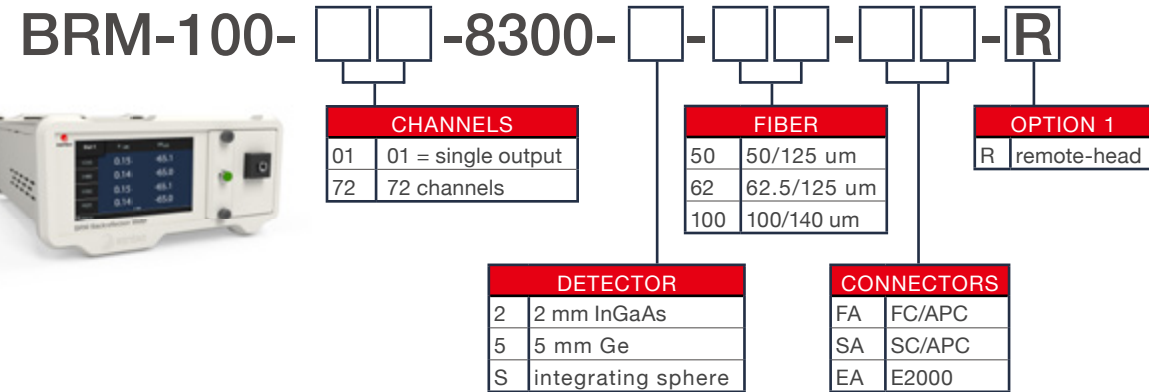

*The standard multimode version contains two lasers at 850 and 1300 nm.
*Other wavelengths are available upon request.

Short Wavelength Single-mode Version

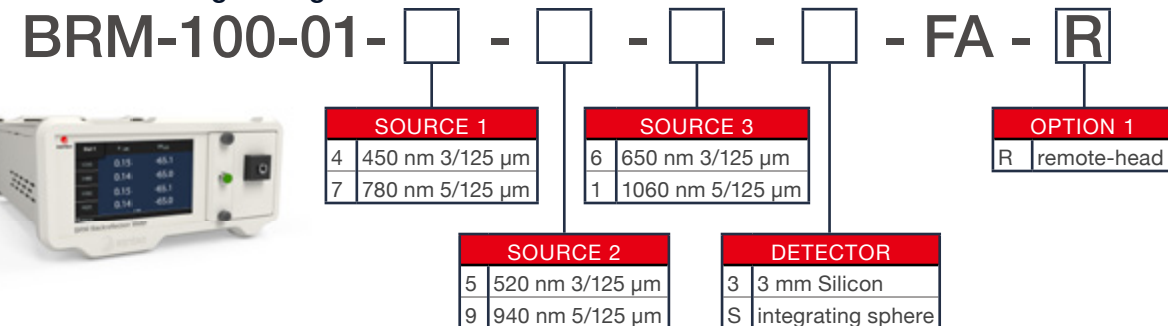

2. Add Accessories

Slide Detector Adapters

SD-



TYPE							
CAP	Cap	DSN	Duplex SN	BRF-BARREL	Barrel for SD-BRF	MT	MT
FC	FC	MPO	Universal MPO	FH-60	Fujikura FJ-60	MDC	MDC
SC	SC	U12	Universal 1.25 mm	FHM-12	Sumitomo FHM-12	MDCMT	MDC MT
LC	LC	U25	Universal 2.5 mm	SLED-BARREL	Barrel for SD-SLED-x	MPO-MICRO	Microlatch MPO
DLC	Duplex LC	BSF	Bare single fiber	ST	ST		
TLC	Tri-LC	BFA-BARREL	Barrel for SD-BRF	E2000	E2000		
DCS	Duplex CS	BRF	Bare ribbon fiber	MTRJ	MT-RJ		

*many more detector adapters available upon request.

Index Matching Block

NTT-Block



BRM Optical / Electrical Specifications

Parameter	Specification	
	Single-mode	Multimode
Fiber Type (μm)	9/125	50/125 62.5/125
Encircled Flux Standard	N/A	IEC-61280-4-1
Operating Wavelengths (nm)	1310 / 1490 / 1550 / 1625 / 1650	850 / 1300
Backreflection Range (dB)	0 to -85	0 to -60
Backreflection Accuracy (dB) ^{1, 2}	± 0.4	
Detector Type	2 mm InGaAs / 5mm Ge	
Power Range (dBm)	0 to -85 / 0 to -60	
Insertion Loss Accuracy (dB)	± 0.05 (< 5 dB loss)	
	± 0.15 (> 5 dB loss)	
Absolute Power Accuracy (dB) ³	± 0.25	
Remote Interface	USB / Ethernet	
Display	5" touch screen	
Input Voltage	100 - 240 V AC, 50 - 60 Hz	
Power Consumption (VA)	60 maximum	

Notes:

¹ Add 0.1 dB to the spec for every 1 dB below -60 dB (single-mode).

² Add 0.1dB to the spec for every 1 dB below -45 dB (multimode).

³ Measured at -10 dBm.

Mechanical / Environmental Specifications

Parameter	Specification
Unit Dimension W x H x D (cm)	23.5 x 12 x 32.5
Shipping Box Dimensions W x H x D (cm)	36.5 x 39 x 53
Unit Weight (kg)	8
Total Shipment Weight (kg)	9
Operating Temperature (°C)	0 to 55
Storage Temperature (°C)	-40 to 70
Humidity (Non-condensing) (°C)	Maximum 95% RH from 0 to 40



In the Box

BRM-100 - Backreflection Meter

- BRM-100
- AC power cord
- Calibration certificate
- Calibrated jumper
- Hybrid test jumper
- Detector cap
- FC detector adapter
- MW3 mandrel wrap



Santec Regional Sales Offices

SANTEC CORPORATION

5823 Ohkusa-Nenjozaka, Komaki,
Aichi, 485-0802, Japan
Tel: +81-568-79-3536 | Fax: +81-568-79-1718

Santec Europe Ltd.

99 Park Drive, Milton Park, Abingdon,
Oxfordshire, OX14 4RY, United Kingdom
Tel: +44-20-3176-1550

SANTEC U.S.A. CORPORATION

433 Hackensack Ave., Hackensack
NJ, 07601, USA. Toll Free: +1-800-SANTEC1 (726-8321)
Tel: +1-201-488-5505 | Fax: +1-201-488-7702

Santec (Shanghai) Corporation Limited

21F Room H, Hua Du Bldg., No.838 Zhangyang Road
Pudong District, Shanghai, 200122, China
Tel: +86-21-5836-1261 | Fax: +86-21-5836-1263

2022© SANTEC CORPORATION Santec reserves the right to make changes in equipment design, components or specifications without notice.

BRM-100-C-E/Ver.1.0 CODE-202303-MB-KT-CPY